

DAIKIN ROOM AIR CONDITIONER *DAIKIN*

OPERATION MANUAL

INVERTER

MODELS

- FDXS25LVMA
- FDXS35LVMA
- FDXS50LVMA
- FDXS60LVMA



Feature

For your comfort and energy saving



ECONO

This function enables efficient operation by limiting the maximum power consumption. It is useful when using the air conditioner and other electrical devices simultaneously.

▶ Page 16









Contents

■ Read before Operation

| | |
|------------------------------------|---|
| Safety Precautions | 3 |
| Name of Parts | 5 |
| Preparation before Operation | 9 |

■ Operation

| | |
|---|----|
|  AUTO · DRY · COOL · HEAT · FAN Operation | 11 |
|  Adjusting the Airflow Rate | 13 |
|  POWERFUL Operation | 14 |
|  OUTDOOR UNIT QUIET Operation | 15 |
|  ECONO Operation | 16 |
|  OFF 0:00 OFF TIMER Operation | 17 |
|  ON 6:00 ON TIMER Operation | 18 |

■ Multi Connection

| | |
|-----------------------------|----|
| Note for Multi System | 19 |
|-----------------------------|----|

■ Care



| | |
|-------------------------|----|
| Care and Cleaning | 21 |
|-------------------------|----|





■ Troubleshooting

| | |
|-----------------------|----|
| Troubleshooting | 23 |
|-----------------------|----|

Safety Precautions



- Keep this manual where the operator can easily find it.
- Read the precautions in this manual carefully before operating the unit.
- The precautions described herein are classified as **WARNING** and **CAUTION**. They both contain important information regarding safety. Be sure to observe all precautions without fail.

|  WARNING |  CAUTION |
|--|---|
| Failure to follow these instructions properly may result in personal injury or loss of life. | Failure to observe these instructions properly may result in property damage or personal injury, which may be serious depending on the circumstances. |

| | |
|---|---|
|  Never attempt. |  Never wet the air conditioner nor the remote controller with water. |
|  Be sure to follow the instructions. |  Never touch the air conditioner nor the remote controller with wet hands. |
|  Be sure to establish an earth connection. | |

- After reading, keep this manual in a convenient place so that you can refer to it whenever necessary. If the equipment is transferred to a new user, be sure also to hand over the manual.

WARNING

-  • In order to avoid fire, explosion or injury, do not operate the unit when harmful, among which flammable or corrosive gases, are detected near the unit.
 - Be aware that prolonged, direct exposure to cool or warm air from the air conditioner, or to air that is too cool or too warm can be harmful to your physical condition and health.
 - Do not place objects, including rods, your fingers, etc., in the air inlet or outlet. Product malfunctioning, product or injury damage may result due to contact with the air conditioner's high-speed fan blades.
 - Do not attempt to repair, dismantle, reinstall or modify the air conditioner yourself as this may result in water leakage, electric shocks or fire hazards. For repairs and reinstallation, consult your Daikin dealer for advice and information.
 - Do not use flammable spray near the air conditioner, or otherwise fire may result.
-
-  • Beware of fire in case of refrigerant leakage. If the air conditioner is not operating correctly, i.e. not generating cool or warm air, refrigerant leakage could be the cause. Consult your dealer for assistance. The refrigerant within the air conditioner is safe and normally does not leak.
However, in the event of a leakage, contact with a naked burner, heater or cooker may result in generation of noxious gas. Do not longer use the air conditioner until a qualified service person confirms that the leakage has been repaired.
 - Do not attempt to install or repair the air conditioner yourself. Improper workmanship may result in water leakage, electric shocks or fire hazards. Please contact your local dealer or qualified personnel for installation and maintenance work.
 - When the air conditioner is malfunctioning (giving off a burning odour, etc.) turn off power to the unit and contact your local dealer. Continued operation under such circumstances may result in a failure, electric shocks or fire hazards.
 - Be sure to install an earth leakage breaker. Failure to install the earth leakage breaker may result in electric shocks or fire.
-
-  • Be sure to earth the unit. Do not earth the unit to a utility pipe, lightning conductor or telephone earth lead. Imperfect earthing may result in electric shocks.

CAUTION

-  • Do not use the air conditioner for purposes other than those for which it is intended. Do not use the air conditioner for cooling precision instruments, food, plants, animals or works of art as this may adversely affect the performance, quality and/or longevity of the object concerned.
- Do not expose plants or animals directly to airflow from the unit as this may cause adverse effects.
- Do not place appliances that produce naked flames in places exposed to the airflow from the unit as this may impair combustion of the burner.
- Do not block air inlets nor outlets. Impaired airflow may result in insufficient performance or trouble.
- Do not sit on the outdoor unit, put things on the unit, or pull the unit. Doing so may cause accidents, such as falling or toppling down, thus resulting in injury, product malfunctioning, or product damage.

CAUTION



- Do not place objects that are susceptible to moisture directly beneath the indoor or outdoor units. Under certain conditions, condensation on the main unit or refrigerant pipes, air filter dirt or drain blockage may cause dripping, resulting in fouling or failure of the object concerned.
- After prolonged use, check the unit stand and its mounts for damage. If they are left in a damaged condition, the unit may fall and cause injury.
- To avoid injury, do not touch the air inlet or aluminium fins of the indoor or outdoor units.
- This appliance is not intended for use by persons (including children) with reduced physical, sensory or mental capabilities, or lack of experience and knowledge, unless they have been given supervision or instruction concerning use of the appliance by a person responsible for their safety.
- Children should be supervised to ensure that they do not play with the unit or its remote controller. Accidental operation by a child may result in impairment of bodily functions and harm health.
- Do not give impact to the indoor and outdoor units, or otherwise product damage may result.
- Do not place flammable items, such as spray cans, within 1 meter of the air outlet. The spray cans may explode as a result of hot air from the indoor or outdoor units.
- Be careful not to let pets urinate on the air conditioner. Urination on the air conditioner may result in electric shocks or fire.



- To avoid oxygen depletion, ensure that the room is adequately ventilated if equipment such as a burner is used together with the air conditioner.
- Before cleaning, be sure to stop unit operation, turn the breaker off or remove the power cord. Otherwise, an electric shock and injury may result.
- Only connect the air conditioner to the specified power supply circuit. Power supplies other than the one specified may result in electric shocks, overheating and fires.
- Arrange the drain hose to ensure smooth drainage. Imperfect drainage may cause wetting of the building, furniture etc.
- Do not place objects in direct proximity of the outdoor unit and do not let leaves and other debris accumulate around the unit. Leaves are a hotbed for small animals which can enter the unit. Once in the unit, such animals can cause malfunctions, smoke or fire when making contact with electrical parts.
- Do not place objects around the indoor unit. Doing so may have an adverse influence on the performance, product quality, and life of the air conditioner.
- This appliance is not intended to be used by persons with reduced physical, sensory or mental capabilities, or with lack of operation knowledge, unless they have been given supervision or instruction concerning the appliance use by person responsible for their safety. Keep out of children's reach to ensure that they do not play with the appliance.



- To avoid electric shocks, do not operate with wet hands.



- Do not wash the air conditioner with water, as this may result in electric shocks or fire.
- Do not place water containers (vases etc.) above the unit, as this may result in electric shocks or fire hazards.

Installation site.

- To install the air conditioner in the following types of environments, consult the dealer.
 - Places with an oily ambient or where steam or soot occurs.
 - Salty environment such as coastal areas.
 - Places where sulfide gas occurs such as hot springs.
 - Places where snow may block the outdoor unit.
 - The indoor unit is at least 1 meter away from any television or radio set (unit may cause interference with the picture or sound).
 - The drain from the outdoor unit must be discharged to a place of good drainage.

Consider nuisance to your neighbours from noises.

- For installation, choose a place as described below.
 - A place solid enough to bear the weight of the unit which does not amplify the operation noise or vibration.
 - A place from where the air discharged from the outdoor unit or the operation noise will not annoy your neighbours.

Electrical work.

- For power supply, be sure to use a separate power circuit dedicated to the air conditioner.

System relocation.

- Relocating the air conditioner requires specialized knowledge and skills. Please consult the dealer if relocation is necessary for moving or remodeling.

Name of Parts

Indoor Unit

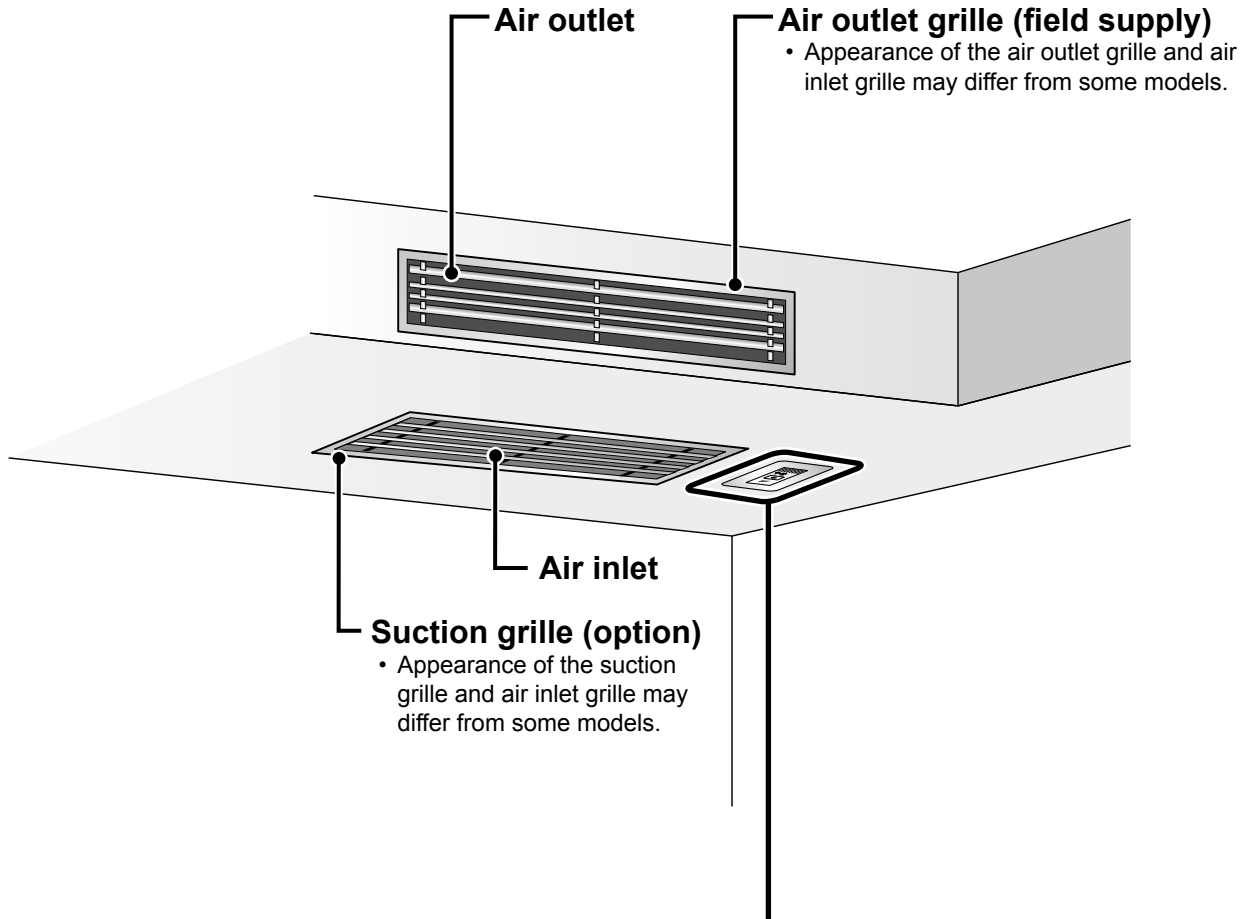

Receiver

Room temperature sensor

- It senses the air temperature around the unit.

OPERATION lamp (green)

TIMER lamp (yellow) ▶Page 17,18

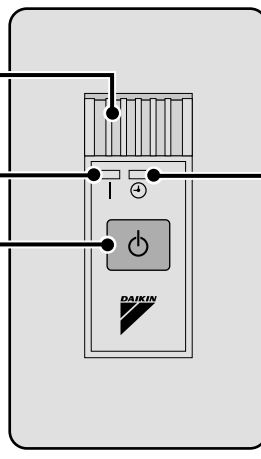

Indoor unit ON/OFF switch

- Press this switch once to start operation. Press once again to stop it.
- The operation mode refers to the following table.

| Mode | Temperature setting | Airflow rate |
|------|---------------------|--------------|
| AUTO | 25°C | AUTO |

- This switch is useful when the remote controller is missing.

Outdoor Unit

- Appearance of the outdoor unit may differ from some models.

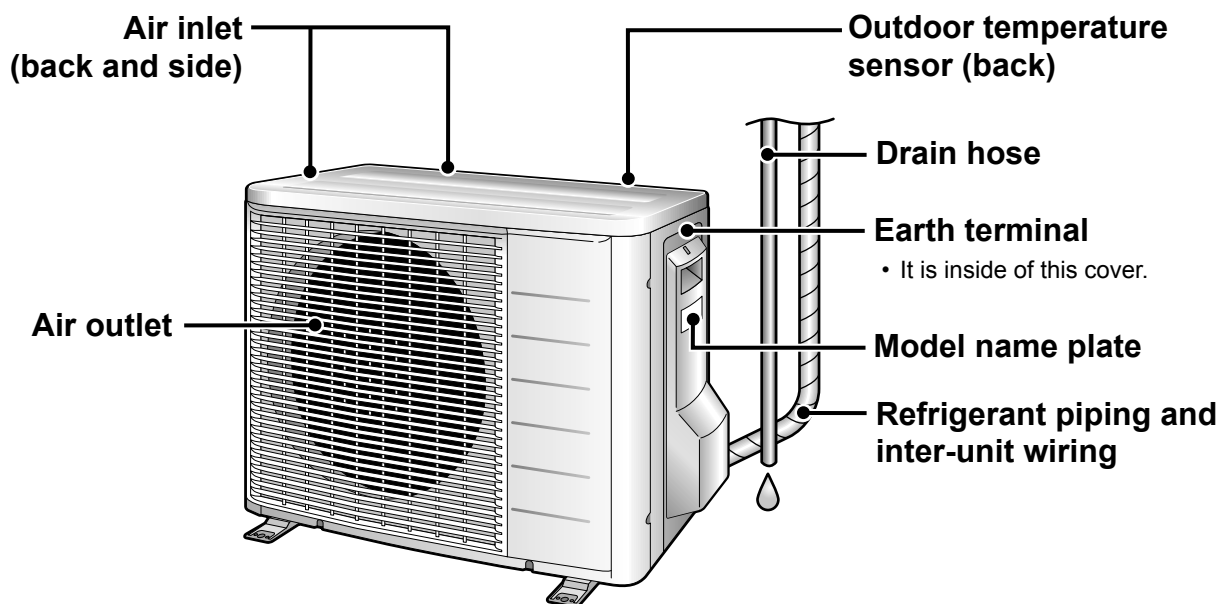

Name of Parts

Remote Controller

Signal transmitter

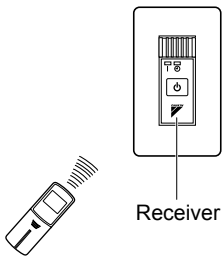

- To use the remote controller, aim the transmitter at the indoor unit. If there is anything to block signals between the unit and the remote controller, such as a curtain, the unit will not operate.
- Do not drop the remote controller. Do not get it wet.
- The maximum distance for communication is approximately 4m.

ECONO button

- ECONO operation. ▶ Page 16

POWERFUL button

- POWERFUL operation. ▶ Page 14

Display (LCD)

- It displays the current settings.
(In this illustration, each section is shown with all its displays on for the purpose of explanation.)

ON/OFF button

- Press this button once to start operation.
Press once again to stop it. ▶ Page 11

TEMPERATURE adjustment buttons

- It changes the temperature setting. ▶ Page 12

Front cover

- Open the front cover. ▶ Page 8

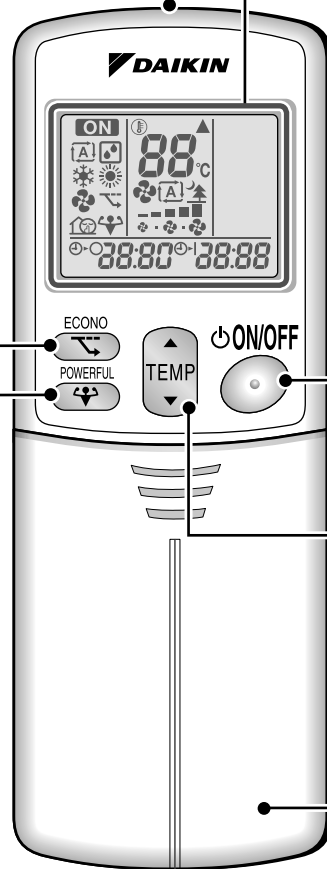

HEAT PUMP model ARC433A103

■ Open the front cover



MODE selector button
• It selects the operation mode.
(AUTO/DRY/COOL/HEAT/FAN) ▶Page 11

FAN setting button
• It selects the airflow rate setting. ▶Page 13

QUIET button
• OUTDOOR UNIT QUIET operation. ▶Page 15

TIMER CANCEL button
• It cancels the timer setting. ▶Page 17, 18

ON TIMER button
▶Page 18

RESET button
• Restart the unit when it freezes.
• Use a thin object to push.

OFF TIMER button
▶Page 17

CLOCK button ▶Page 10

TIMER setting button
• It changes the time setting. ▶Page 17, 18

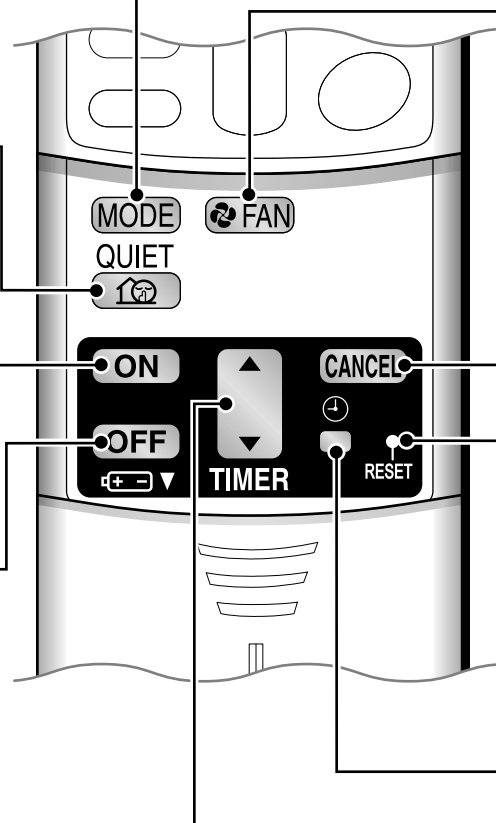

Preparation before Operation

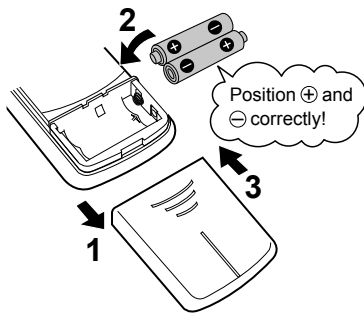

■ To set the batteries

- 1. Slide the front cover to take it off.**
- 2. Set two dry batteries AAA.LR03 (alkaline).**
- 3. Set the front cover as before.**

■ To fix the remote controller holder on the wall

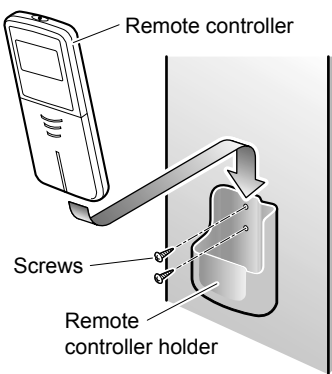

- 1. Choose a place from where the signals reach the unit.**
- 2. Fix the holder to a wall, a pillar, etc. with the screws supplied with the holder.**
- 3. Place the remote controller in the remote controller holder.**

■ Turn the breaker on

NOTE

■ Notes on batteries

- When replacing the batteries, use batteries of the same type, and replace both old batteries together.
- When the system is not used for a long time, take the batteries out.
- The batteries will last for approximately 1 year. If the remote controller display begins to fade and the degradation of reception performance occurs within a year, however, replace both batteries with new, size AAA.LR03 (alkaline).
- The attached batteries are provided for the initial use of the system.
The usable period of the batteries may be short depending on the manufactured date of the air conditioner.

■ Notes on remote controller

- Never expose the remote controller to direct sunlight.
- Dust on the signal transmitter or receiver will reduce the sensitivity. Wipe off dust with soft cloth.
- Signal communication may be disabled if an electronic-starter-type fluorescent lamp (such as inverter-type lamps) is in the room. Consult the shop if that is the case.
- If the remote controller signals happen to operate another appliance, move that appliance to somewhere else, or consult the service shop.

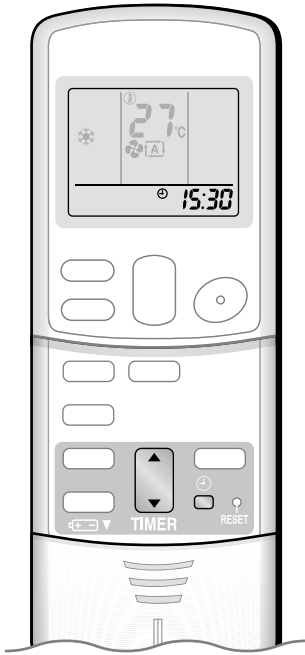

■ To set the clock

1. Press  .

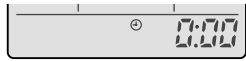

"0:00" is displayed.

"" blinks.

2. Press  **to set the clock to the present time.**

3. Press  .

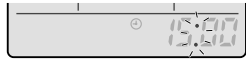

"*" blinks.



AUTO · DRY · COOL · HEAT · FAN Operation

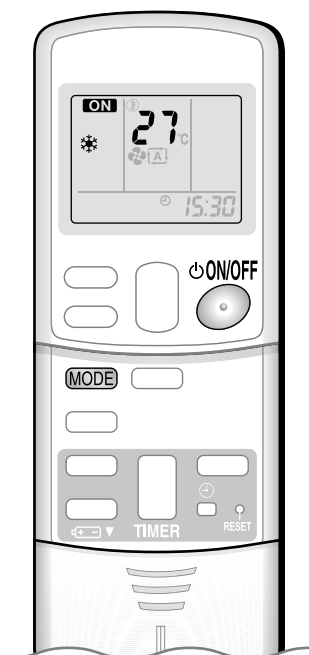

The air conditioner operates with the operation mode of your choice. From the next time on, the air conditioner will operate with the same operation mode.

■ To start operation

1. Press **MODE** and select an operation mode.

- Each pressing of the button advances the mode setting in sequence.

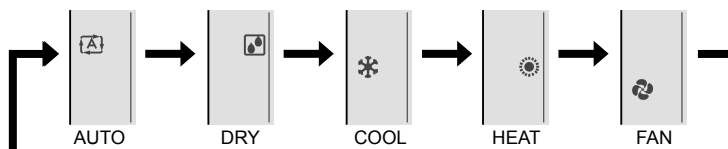

2. Press **ON/OFF**.

- “**ON**” is displayed on the LCD.
- The OPERATION lamp lights green.

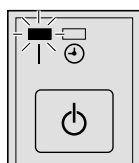

Display

■ To stop operation

Press **ON/OFF** again.

- “**ON**” disappears from the LCD.
- The OPERATION lamp goes off.

NOTE

| MODE | Notes on each operation mode |
|------|---|
| HEAT | <ul style="list-style-type: none"> • Since this air conditioner heats the room by taking heat from outdoor air to indoors, the heating capacity becomes smaller in lower outdoor temperatures. If the heating effect is insufficient, it is recommended to use another heating appliance in combination with the air conditioner. • The heat pump system heats the room by circulating hot air around all parts of the room. After the start of HEAT operation, it takes some time before the room gets warmer. • In HEAT operation, frost may occur on the outdoor unit and lower the heating capacity. In that case, the system switches into defrosting operation to take away the frost. • During defrosting operation, hot air does not flow out of indoor unit. |
| COOL | <ul style="list-style-type: none"> • This air conditioner cools the room by releasing the heat in the room outside. Therefore, the cooling performance of the air conditioner may be degraded if the outdoor temperature is high. |
| DRY | <ul style="list-style-type: none"> • The computer chip works to rid the room of humidity while maintaining the temperature as much as possible. It automatically controls temperature and airflow rate, so manual adjustment of these functions is unavailable. |
| AUTO | <ul style="list-style-type: none"> • In AUTO operation, the system selects an appropriate operation mode (COOL or HEAT) based on the room and outside temperatures and starts the operation. • The system automatically reselects setting at a regular interval to bring the room temperature to user-setting level. |
| FAN | <ul style="list-style-type: none"> • This mode is valid for fan only. |

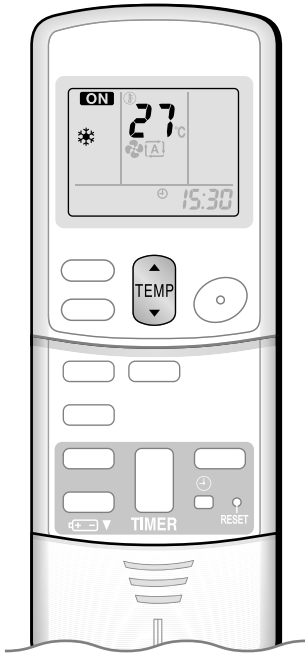

■ To change the temperature setting

Press .

- The displayed items on the LCD will change whenever either one of the buttons is pressed.

| COOL operation | HEAT operation | AUTO operation | DRY or FAN operation |
|--|----------------|----------------|--|
| 18-32°C | 10-30°C | 18-30°C | The temperature setting is not variable. |
| Press ▲ to raise the temperature and press ▼ to lower the temperature. | | | |

■ Operating conditions

■ Recommended temperature setting

- For cooling: 26-28°C
- For heating: 20-24°C

■ Tips for saving energy

- Be careful not to cool (heat) the room too much.
Keeping the temperature setting at a moderate level helps save energy.
- Cover windows with a blind or a curtain.
Blocking sunlight and air from outdoors increases the cooling (heating) effect.
- Clogged air filters cause inefficient operation and waste energy. Clean them once in about every 2 weeks. ▶Page 21

■ Notes on the operating conditions

- The air conditioner always consumes a small amount of electricity even while it is not operating.
- If you are not going to use the air conditioner for a long period, for example in spring or autumn, turn the breaker off.
- Use the air conditioner in the following conditions.

| MODE | Operating conditions | If operation is continued out of this range |
|------|---|---|
| COOL | Outdoor temperature : 10-46°C Indoor temperature : 18-32°C Indoor humidity : 80% max. | <ul style="list-style-type: none"> • A safety device may work to stop the operation. (In multi system, it may work to stop the operation of the outdoor unit only.) • Condensation may occur on the indoor unit and drip. |
| HEAT | Outdoor temperature : -15-24°C Indoor temperature : 10-30°C | <ul style="list-style-type: none"> • A safety device may work to stop the operation. |
| DRY | Outdoor temperature : 10-46°C Indoor temperature : 18-32°C Indoor humidity : 80% max. | <ul style="list-style-type: none"> • A safety device may work to stop the operation. • Condensation may occur on the indoor unit and drip. |

- Operation outside this humidity or temperature range may cause a safety device to disable the system.



Adjusting the Airflow Rate

■ To adjust the airflow rate setting



Press  FAN.

- Each pressing of  FAN advances the airflow rate setting in sequence.

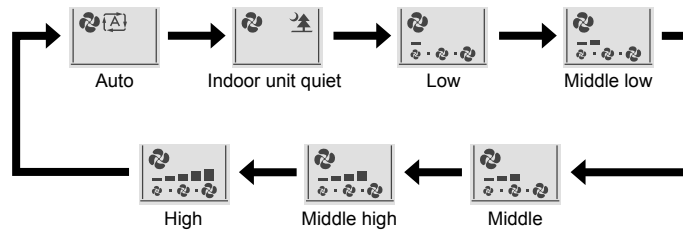

- When the airflow is set to “”, indoor unit quiet operation will start and the noise from the unit will become quieter.
- In indoor unit quiet operation, the airflow rate is set to a weak level.
- In DRY operation, the airflow rate setting is not variable.

NOTE

■ Note on airflow rate setting

- At smaller airflow rates, the cooling (heating) effect is also smaller.



POWERFUL Operation



POWERFUL operation quickly maximises the cooling (heating) effect in any operation mode. You can get the maximum capacity.

■ To start POWERFUL operation

Press  during operation.

- POWERFUL operation ends in 20 minutes. Then the system automatically operates again with the previous settings which were used before POWERFUL operation.
- “” is displayed on the LCD.

■ To cancel POWERFUL operation

Press  again.

- “” disappears from the LCD.

[Example]

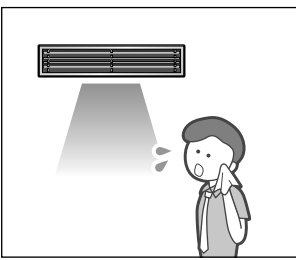

■ **Normal operation**

- When you want to get the cooling effect quickly, start the POWERFUL operation.

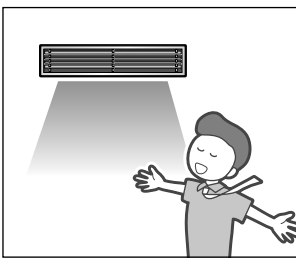

■ **POWERFUL operation**

- POWERFUL operation will work for 20 minutes.

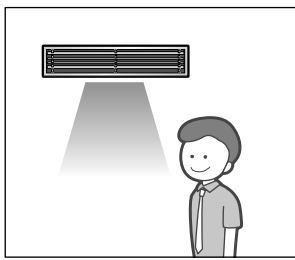

■ **Back to normal operation**

NOTE

■ Notes on POWERFUL operation

- When using POWERFUL operation, there are some functions which are not available.
- POWERFUL operation cannot be used together with ECONO and OUTDOOR UNIT QUIET operation. Priority is given to the function of whichever button is pressed last.
- POWERFUL operation can only be set when the unit is running. Pressing the operation stop button causes the settings to be canceled, and “” disappears from the LCD.
- POWERFUL operation will not increase the capacity of the air conditioner if the air conditioner is already in operation with its maximum capacity demonstrated.
- **In COOL, HEAT and AUTO operation**
To maximize the cooling (heating) effect, the capacity of outdoor unit is increased and the airflow rate is fixed to the maximum setting. The temperature and airflow settings are not variable.
- **In DRY operation**
The temperature setting is lowered by 2.5°C and the airflow rate is slightly increased.
- **In FAN operation**
The airflow rate is fixed to the maximum setting.
- **When using priority-room setting**
See “Note for multi system”. ▶Page 19



OUTDOOR UNIT QUIET Operation

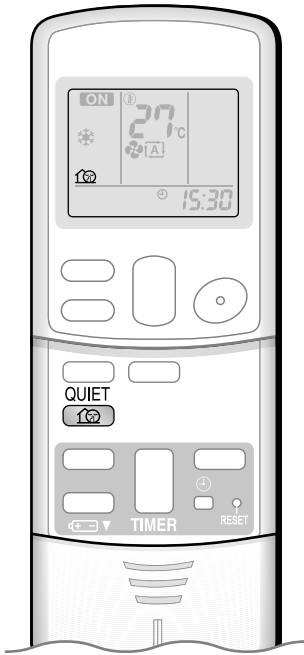

OUTDOOR UNIT QUIET operation lowers the noise level of the outdoor unit by changing the frequency and fan speed on the outdoor unit. This function is convenient during the night.

■ To start OUTDOOR UNIT QUIET operation

Press .

- “” is displayed on the LCD.

■ To cancel OUTDOOR UNIT QUIET operation

Press  again.

- “” disappears from the LCD.

[Example] Using the OUTDOOR UNIT QUIET operation during the night.



- The noise level of the outdoor unit will be lower.
This is convenient when you need to consider for your neighborhood.

NOTE

■ Notes on OUTDOOR UNIT QUIET operation

- If using a multi system, the OUTDOOR UNIT QUIET operation will work only when this function is set on all operated indoor units. However, if using priority room setting, refer to note for multi system. ▶Page 19
- This function is available in COOL, HEAT, and AUTO operation.
This is not available in FAN and DRY operation.
- POWERFUL operation and OUTDOOR UNIT QUIET operation cannot be used at the same time.
Priority is given to the function of whichever button is pressed last.
- Even the operation is stopped using the remote controller or the indoor unit ON/OFF switch when using OUTDOOR UNIT QUIET operation, “” will remain on the remote controller display.
- OUTDOOR UNIT QUIET operation will drop neither the frequency nor fan speed if they have been already dropped low enough.



ECONO Operation



ECONO operation is a function which enables efficient operation by limiting the maximum power consumption value. This function is useful for cases in which attention should be paid to ensure a circuit breaker will not trip when the product runs alongside other appliances.

■ To start ECONO operation

Press  during operation.

- “” is displayed on the LCD.

■ To cancel ECONO operation

Press  again.

- “” disappears from the LCD.

[Example]

Normal operation



- In case the air conditioner and other appliances which require high power consumption are used at same time, a circuit breaker may trip if the air conditioner operate with its maximum capacity.

ECONO operation

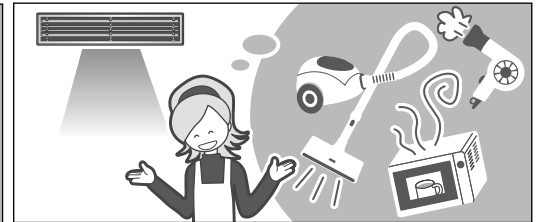

- The maximum power consumption of the air conditioner is limited by using ECONO operation. The circuit breaker will hardly trip even if the air conditioner and other appliances are used at same time.

Running current and power consumption

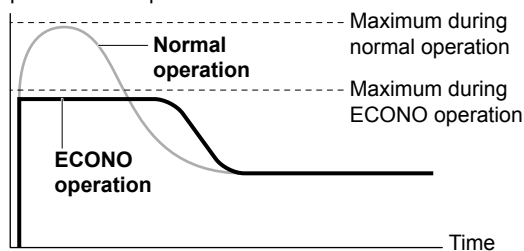

From start up until set temperature is reached

- This diagram is a representation for illustrative purposes only. The maximum running current and power consumption of the air conditioner in ECONO operation vary with the connecting outdoor unit.

NOTE

■ Notes on ECONO operation

- ECONO operation can only be set when the unit is running.
- ECONO operation is a function which enables efficient operation by limiting the power consumption of the outdoor unit (operating frequency).
- ECONO operation functions in AUTO, COOL, DRY, and HEAT operation.
- POWERFUL and ECONO operation cannot be used at the same time. Priority is given to the function of whichever button is pressed last.
- If the level of power consumption is already low, ECONO operation will not drop the power consumption.



OFF TIMER Operation

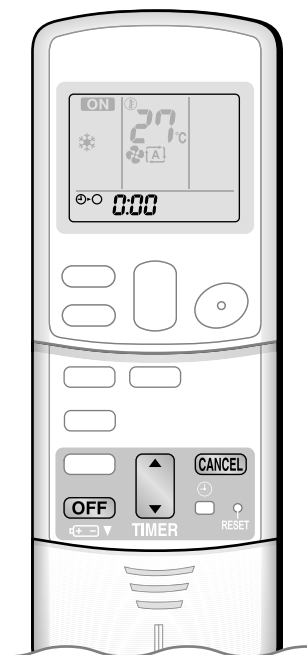

Timer functions are useful for automatically switching the air conditioner on or off at night or in the morning. You can also use OFF TIMER and ON TIMER in combination.

■ To use OFF TIMER operation

- Check that the clock is correct.
If not, set the clock to the present time. ▶Page 10

1. Press **OFF**.

- “⏻” disappears from the LCD.
- 
- “0:00” is displayed on the LCD.
 - “⏻▶○” blinks.

2. Press until the time setting reaches the point you like.

- Each pressing of either button increases or decreases the time setting by 10 minutes. Holding down either button changes the time setting rapidly.

3. Press **OFF** again.

- “⏻▶○” and setting time are displayed on the LCD.
- The TIMER lamp lights yellow.

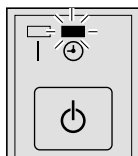

Display

■ To cancel OFF TIMER operation

Press **CANCEL**.

- “⏻▶○” disappear from the LCD.
- “⏻” is displayed on the LCD.
- The TIMER lamp goes off.

NOTE

■ Notes on TIMER operation

- When TIMER is set, the present time is not displayed.
- Once you set ON/OFF TIMER, the time setting is kept in the memory. The memory is canceled when remote controller batteries are replaced.
- When operating the unit via the ON/OFF timer, the actual length of operation may vary from the time entered by the user. (Maximum approximately 10 minutes)

■ NIGHT SET mode

- When the OFF TIMER is set, the air conditioner automatically adjusts the temperature setting (0.5°C up in COOL, 2.0°C down in HEAT) to prevent excessive cooling (heating) for your pleasant sleep.



ON TIMER Operation

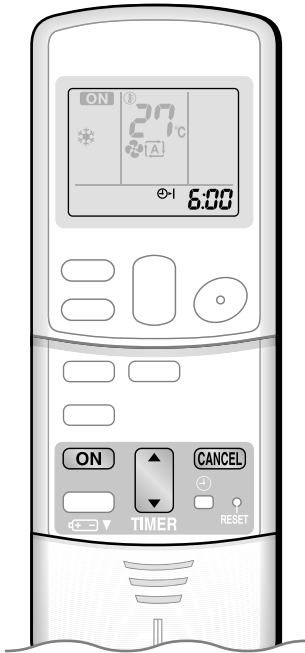

■ To use ON TIMER operation

- Check that the clock is correct.
If not, set the clock to the present time. ▶Page 10

1. Press **ON** .

- “⏰” disappears from the LCD.
- 
- “6:00” is displayed on the LCD.
 - “⏰ ▶ |” blinks.

2. Press until the time setting reaches the point you like.

- Each pressing of either button increases or decreases the time setting by 10 minutes.
Holding down either button changes the setting rapidly.

3. Press **ON** again.

- “⏰ ▶ |” and setting time are displayed on the LCD.
- The TIMER lamp lights yellow.

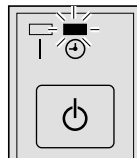

Display

■ To cancel ON TIMER operation

Press **CANCEL** .

- “⏰ ▶ |” disappears from the LCD.
- “⏰” is displayed on the LCD.
- The TIMER lamp goes off.

■ To combine ON TIMER and OFF TIMER

- A sample setting for combining the 2 timers is shown below.

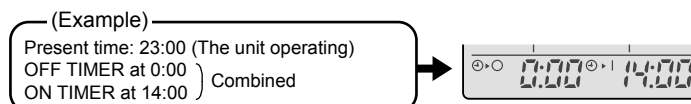

NOTE

■ In the following cases, set the timer again.

- After a breaker has turned off.
- After a power failure.
- After replacing batteries in the remote controller.

Note for Multi System

Multi system has one outdoor unit connected to multiple indoor units.

■ Selecting the operation mode

With the priority room setting present but inactive or not present.

When more than one indoor unit is operating, priority is given to the first unit that was turned on.

In this case, set the units that are turned on later to the same operation mode as the first unit.

Otherwise, they will enter the standby state, and the OPERATION lamp will flash: this does not indicate malfunction.

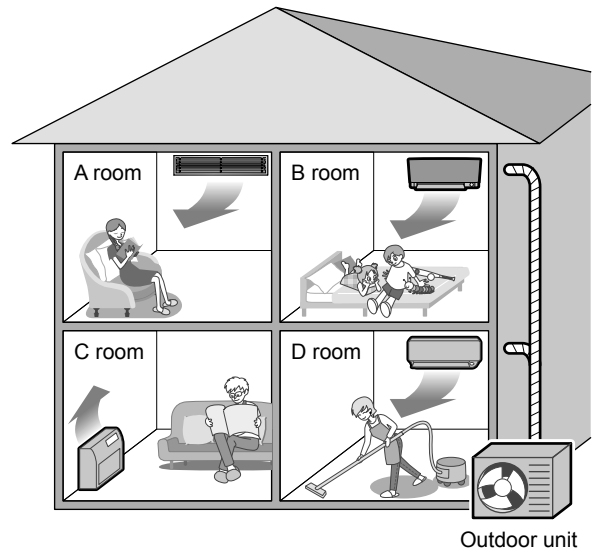

NOTE

■ Notes on operation mode for multi system

- COOL, DRY and FAN operation may be used at the same time.
- AUTO operation automatically selects COOL operation or HEAT operation based on the room temperature. Therefore, AUTO operation is available when selecting the same operation mode as that of the room with the first unit to be turned on.

⚠ CAUTION

- Normally, the operation mode in the room where the unit is first run is given priority, but the following situations are exceptions, so please keep this in mind.

If the operation mode of the first room is **FAN operation**, then using **HEAT operation** in any room after this will give priority to **HEAT operation**. In this situation, the air conditioner running in FAN operation will go on standby, and the OPERATION lamp will flash.

With the priority room setting active.

Refer to "Priority room setting" on the next page.

■ NIGHT QUIET mode (Available only for COOL operation)

NIGHT QUIET mode requires initial programming during installation. Please consult your retailer or dealer for assistance. NIGHT QUIET mode reduces the operation noise of the outdoor unit during the nighttime hours to prevent annoyance to neighbors.

- The NIGHT QUIET mode is activated when the temperature drops 6°C or more below the highest temperature recorded that day. Therefore, when the temperature difference is less than 4°C, this function will not be activated.
- NIGHT QUIET mode reduces slightly the cooling efficiency of the unit.

■ OUTDOOR UNIT QUIET operation

Refer to "OUTDOOR UNIT QUIET operation". ▶Page 15

With the priority room setting present but inactive or not present.

When using the OUTDOOR UNIT QUIET operation feature with the Multi system, set all indoor units to OUTDOOR UNIT QUIET operation using their remote controllers.

When clearing OUTDOOR UNIT QUIET operation, clear one of the operating indoor units using their remote controller. However OUTDOOR UNIT QUIET operation display remains on the remote controller for other rooms.

We recommend you release all rooms using their remote controllers.

With the priority room setting active.

Refer to "Priority room setting" on the next page.

■ COOL / HEAT mode lock

The COOL / HEAT mode lock requires initial programming during installation. Please consult your authorized dealer for assistance. The COOL / HEAT mode lock sets the unit forcibly to either COOL or HEAT operation. This function is convenient when you wish to set all indoor units connected to the multi system to the same operation mode.

■ Priority room setting

The priority room setting requires initial programming during installation. Please consult your authorized dealer for assistance. The room designated as the priority room takes priority in the following situations.

Operation mode priority

- As the operation mode of the priority room takes precedence, the user can select a different operation mode from other rooms.

[Example]

- Room A is the priority room in the examples.
When COOL operation is selected in room A while operating the following modes in room B, C and D :

| Operation mode in room B, C and D | Status of room B, C and D when the unit in room A is in COOL operation |
|-----------------------------------|--|
| COOL or DRY or FAN | Current operation mode maintained |
| HEAT | The unit enters standby mode. Operation resumes when the room A unit stops operating. |
| AUTO | If the unit is set to COOL operation, operation continues. If the unit is set to HEAT operation, it enters standby mode. Operation resumes when the room A unit stops operating. |

Priority when POWERFUL operation is used

[Example]

- Room A is the priority room in the examples.
The indoor units in rooms A, B, C and D are all operating. If the unit in room A enters POWERFUL operation, operation capacity will be concentrated in room A. In such a case, the cooling (heating) efficiency of the units in room B, C and D may be slightly reduced.

Priority when using OUTDOOR UNIT QUIET operation

[Example]

- Room A is the priority room in the examples.
Just by setting the unit in room A to QUIET operation, the air conditioner starts OUTDOOR UNIT QUIET operation. You don't have to set all the operated indoor units to QUIET operation.

Care and Cleaning

CAUTION

- Only a qualified service person is allowed to perform maintenance.
- Before cleaning, be sure to stop the operation and turn the breaker off.

■ Air filter

1. Removing the air filter.

- Rear suction
Pull the bottom side of the air filter backwards, over the bends.
- Bottom suction
Pull the filter over the bends situated at the backside of the unit.

2. Cleaning the air filter.

- Remove dust from the air filter using a vacuum cleaner and gently rinse them in cool water. Do not use detergent or hot water to avoid filter shrinking or deformation. After cleaning dry them in the shade.

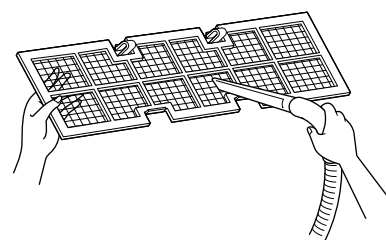

3. Replacing the air filter.

- Rear suction
Hook the filter behind the flap situated at the top of the unit and push the other side gently over the bends.
- Bottom suction
Hook the filter behind the flap situated at the middle of the unit and push the other side gently over the bends.

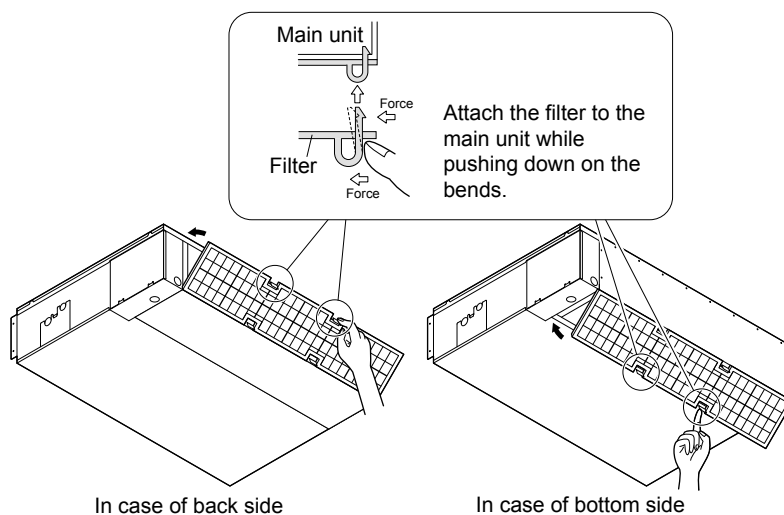

■ Drain pan

- Clean the drain pan periodically, or drain piping may be clogged with dust and may result in water leakage. Ask your DAIKIN dealer to clean them.
- Prepare a cover locally to prevent any dust in the air around the indoor unit from getting in the drain pan, if there is a great deal of dust present.

CAUTION



- Do not operate the air conditioner without filters, this to avoid dust accumulation inside the unit.
- Do not remove the air filter except when cleaning. Unnecessary handling may damage the filter.
- Do not use gasoline, benzene, thinner, polishing powder, liquid insecticide. It may cause discoloring or warping.
- Do not let the indoor unit get wet. It may cause an electric shock or a fire.
- Operation with dusty air filters lowers the cooling and heating capacity and wastes energy.
- The suction grille is option.
- Do not use water or air of 50°C or higher for cleaning air filters and outside panels.
- Ask your DAIKIN dealer how to clean it.

■ Check the units

- Check that the base, stand and other fittings of the outdoor unit are not decayed or corroded.
- Check that nothing blocks the air inlets and the outlets of the indoor unit and the outdoor unit.
- Check that the drain comes smoothly out of the drain hose during COOL or DRY operation.
 - If no drain water is seen, water may be leaking from the indoor unit. Stop operation and consult the service shop if this is the case.

■ Before a long idle period

1. Operate the FAN only for several hours on a fine day to dry out the inside.

- Press  and select “” operation.
- Press  and start the operation.

2. After operation stops, turn off the breaker for the room air conditioner.

3. Clean the air filters and set them again.

4. Take out batteries from the remote controller.

- When a multi outdoor unit is connected, make sure the heating operation is not used at the other room before you use the fan operation. 

■ We recommend periodical maintenance

- In certain operating conditions, the inside of the air conditioner may get foul after several seasons of use, resulting in poor performance. It is recommended to have periodical maintenance by a specialist aside from regular cleaning by the user.
- For specialist maintenance, contact the service shop where you bought the air conditioner.
- The maintenance cost must be born by the user.

Troubleshooting

■ These cases are not troubles.

- The following cases are not air conditioner troubles but have some reasons. You may just continue using it.

Indoor unit

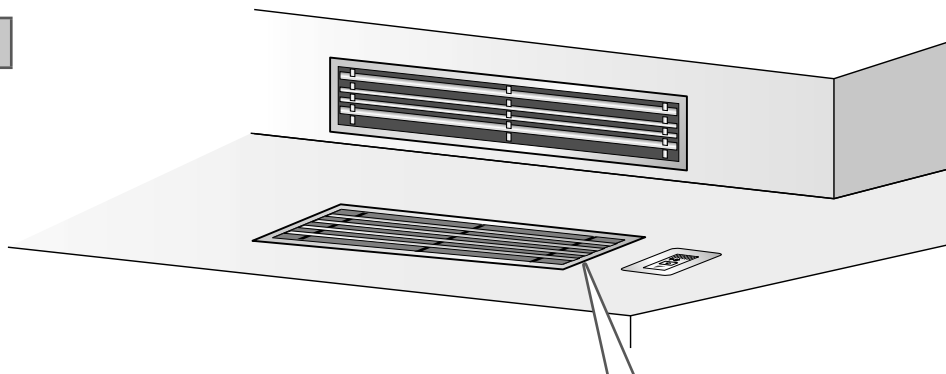

The HEAT operation stops suddenly and a flowing sound is heard.

- The system is taking away the frost on the outdoor unit. You should wait for about 4 to 12 minutes.

Operation does not start soon.

- When "ON/OFF" button was pressed soon after operation was stopped.
- When the mode was reselected.
 - This is to protect the air conditioner. You should wait for about 3 minutes.

A sound is heard.

■ A sound like a flow of water

- This sound is generated because the refrigerant in the air conditioner is flowing.
- This is a pumping sound of the water in the air conditioner and heard when the water is pumped out from the air conditioner in cooling or drying operation.
- The refrigerant flows in the air conditioner even if the air conditioner is not working when the indoor units in other rooms are in operation.

■ Blowing sound

- This sound is generated when the flow of the refrigerant in the air conditioner is switched over.

■ Ticking sound

- This sound is generated when the size of the air conditioner slightly expands or shrinks as a result of temperature changes.

■ Whistling sound

- This sound is generated when refrigerant flows during defrosting operation.

■ Clicking sound during operation or idle time

- This sound is generated when the refrigerant control valves or the electrical parts operate.

■ Clopping sound

- This sound is heard from the inside of the air conditioner when the exhaust fan is activated while the room doors are closed. Open the window or turn off the exhaust fan.

Outdoor unit

The outdoor unit emits water or steam.

■ In HEAT operation

- The frost on the outdoor unit melts into water or steam when the air conditioner is in defrost operation.

■ In COOL or DRY operation

- Moisture in the air condenses into water on the cool surface of outdoor unit piping and drips.

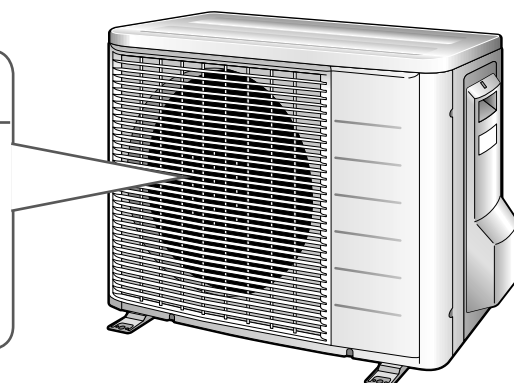

- Troubleshooting measures are classified into the following two types on a remedial basis. Take an appropriate measure according to the symptom.



Not trouble

- These cases are not troubles. You may just continue using it.



Check

- Please check again before calling a repair person.

The air conditioner does not operate. (OPERATION lamp is off.)

- Hasn't a breaker turned off or a fuse blown?
- Isn't it a power failure?
- Are batteries set in the remote controller?
- Is the timer setting correct?



Hot air does not flow out soon after the start of HEAT operation.

- The air conditioner is warming up. You should wait for 1 to 4 minutes. (The system is designed to start discharging air only after it has reached a certain temperature.)



Operation stopped suddenly. (OPERATION lamp flashes.)

- Are the air filters clean?
- Is there anything to block the air inlet or the outlet of the indoor and the outdoor units?
- Clean the air filters or take all obstacles away and turn the breaker off. Then turn it on again and try operating the air conditioner with the remote controller. If the lamp still flashes, call the service shop where you bought the air conditioner.
- Are operation modes all the same for indoor units connected to outdoor units in the **multi system**?
If not, set all indoor units to the same operation mode and confirm that the lamps blink.
Moreover, when the operation mode is in "AUTO", set all indoor unit operation modes to "COOL" or "HEAT" for a moment and check again that the lamps are normal.
If the lamps stop blinking after the above steps, there is no malfunction. ▶Page 19



Operation stopped suddenly. (OPERATION lamp is on.)

- For system protection, the air conditioner may stop operating on a sudden large voltage fluctuation. It automatically resumes operation in about 3 minutes.



Mist comes out of the indoor unit.

- This happens when the air in the room is cooled into mist by the cold airflow during COOL operation.
- This is because the air in the room is cooled by the heat exchanger and becomes mist during defrost operation.



Troubleshooting

Cooling (heating) effect is poor.

- Are the air filters clean?
- Is there anything to block the air inlet or the outlet of the indoor and the outdoor units?
- Is the temperature setting appropriate?
- Are the windows and doors closed?
- Are the airflow rate and the airflow direction set appropriately?



The outdoor fan rotates while the air conditioner is not in operation.

■ After operation is stopped

- The outdoor fan continues rotating for another 60 seconds for system protection.

■ While the air conditioner is not in operation

- When the outdoor temperature is very high, the outdoor fan starts rotating for system protection.



Remote controller does not work properly.

- No remote controller signals are displayed.
- The remote controller sensitivity is low.
- The display is low in contrast or blacked out.
- The display runs out of control.
 - The batteries are dying and the remote controller is malfunctioning. Replace all the batteries with new, size AAA.LR03 (alkaline). For details, refer to set the batteries of this manual. ▶Page 9



An abnormal functioning happens during operation.

- The air conditioner may malfunction with lightning or radio waves. Turn the breaker off, turn it on again and try operating the air conditioner with the remote controller.



The indoor unit gives out odour.

- This happens when smells of the room, furniture, or cigarettes are absorbed into the unit and discharged with the airflow.
(If this happens, we recommend you to have the indoor unit washed by a technician. Consult the service shop where you bought the air conditioner.)



■ Call the service shop immediately

WARNING

- **When an abnormality (such as a burning smell) occurs, stop operation and turn the breaker off.**
 - Continued operation in an abnormal condition may result in troubles, electric shocks or fire.
 - Consult the service shop where you bought the air conditioner.
- **Do not attempt to repair or modify the air conditioner by yourself.**
 - Incorrect work may result in electric shocks or fire.
 - Consult the service shop where you bought the air conditioner.

If one of the following symptoms takes place, call the service shop immediately.

- The power cord is abnormally hot or damaged.
- An abnormal sound is heard during operation.
- The safety breaker, a fuse, or the earth leakage breaker cuts off the operation frequently.
- A switch or a button often fails to work properly.
- There is a burning smell.
- Water leaks from the indoor unit.

Turn the breaker off and call the service shop.



■ After a power failure

- The air conditioner automatically resumes operation in about 3 minutes. You should just wait for a while.

■ Lightning

- If lightning may strike the neighbouring area, stop operation and turn the breaker off for system protection.

■ Disposal requirements

- Dismantling of the unit, treatment of the refrigerant, oil and eventual other parts, should be done in accordance with the relevant local and national regulations.

Troubleshooting

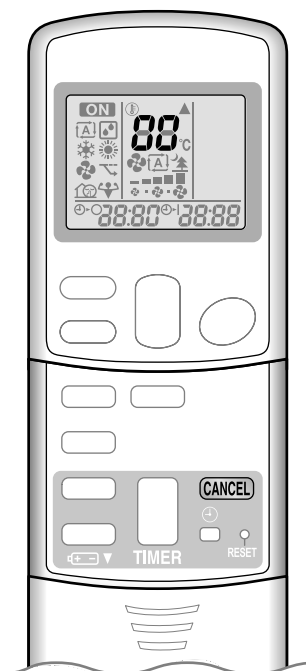

■ Fault diagnosis by remote controller

- In the ARC433A series, the temperature display sections on the main unit indicate corresponding codes.

1. When **CANCEL is held down for 5 seconds, a “00” indication flashes on the temperature display section.**

2. Press **CANCEL repeatedly until a continuous beep is produced.**

- The code indication changes as shown below, and notifies with a long beep.

| | CODE | MEANING |
|--------------|---|--|
| SYSTEM | 00 | NORMAL |
| | UA | INDOOR-OUTDOOR UNIT COMBINATION FAULT |
| | U0 | REFRIGERANT SHORTAGE |
| | U2 | DROP VOLTAGE OR MAIN CIRCUIT OVERVOLTAGE |
| | U4 | FAILURE OF TRANSMISSION (BETWEEN INDOOR UNIT AND OUTDOOR UNIT) |
| INDOOR UNIT | A1 | INDOOR PCB DEFECTIVENESS |
| | A5 | HIGH PRESSURE CONTROL OR FREEZE-UP PROTECTOR |
| | A6 | FAN MOTOR FAULT |
| | C4 | FAULTY HEAT EXCHANGER TEMPERATURE SENSOR |
| | C9 | FAULTY SUCTION AIR TEMPERATURE SENSOR |
| OUTDOOR UNIT | EA | COOLING-HEATING SWITCHING ERROR |
| | E1 | CIRCUIT BOARD FAULT |
| | E5 | OL STARTED |
| | E6 | FAULTY COMPRESSOR START UP |
| | E7 | DC FAN MOTOR FAULT |
| | E8 | OVERCURRENT INPUT |
| | F3 | HIGH TEMPERATURE DISCHARGE PIPE CONTROL |
| | F6 | HIGH PRESSURE CONTROL (IN COOLING) |
| | H0 | SENSOR FAULT |
| | H6 | OPERATION HALT DUE TO FAULTY POSITION DETECTION SENSOR |
| | H8 | DC CURRENT SENSOR FAULT |
| | H9 | FAULTY SUCTION AIR TEMPERATURE SENSOR |
| | J3 | FAULTY DISCHARGE PIPE TEMPERATURE SENSOR |
| | J6 | FAULTY HEAT EXCHANGER TEMPERATURE SENSOR |
| | L3 | ELECTRICAL PARTS HEAT FAULT |
| L4 | HIGH TEMPERATURE AT INVERTER CIRCUIT HEATSINK | |
| L5 | OUTPUT OVERCURRENT | |
| P4 | FAULTY INVERTER CIRCUIT HEATSINK TEMPERATURE SENSOR | |

NOTE

- A short beep and 2 consecutive beeps indicate non-corresponding codes.
- To cancel the code display, hold the **CANCEL** down for 5 seconds. The code display also cancel itself if the button is not pressed for 1 minute.

MEMO

MEMO

MEMO

Quick Reference

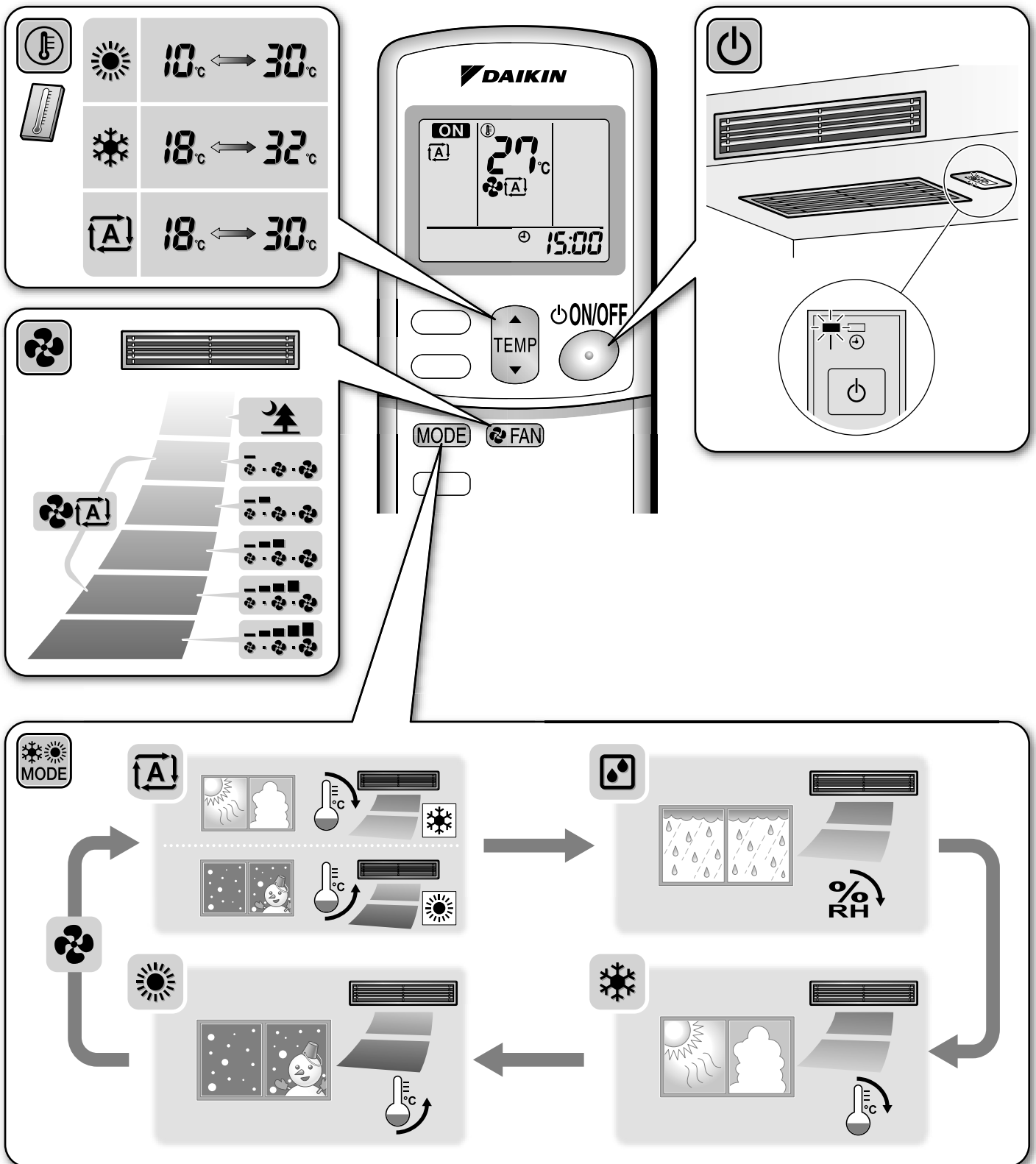

DAIKIN INDUSTRIES, LTD.

Head office:
 Umeda Center Bldg., 2-4-12, Nakazaki-Nishi,
 Kita-ku, Osaka, 530-8323 Japan

Tokyo office:
 JR Shinagawa East Bldg., 2-18-1, Konan,
 Minato-ku, Tokyo, 108-0075 Japan
http://www.daikin.com/global_ac/



Two-dimensional bar code is a code for manufacturing.

3P297309-1 M11B122 (1111)HT